

FERRULE FOR 1SN/2SN/2SC

BOCCOLA PER TUBO 1SN/2SN/2SC
 JUPE POUR 1SN/2SN/2SC
 PRESSHÜLSE 1SN/2SN/2SC
 CASQUILLO PARA 1SN/2SN/2SC

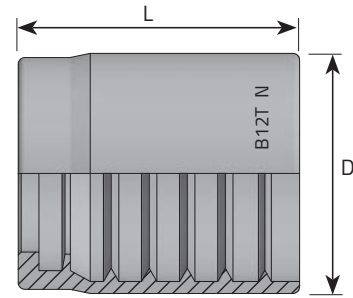

No skive - Senza pelatura - Non-dénudable -
 Nichtschaelfassung - Sin pelar

IDENTIFICATION: PRINTED CODE OR SCRATCHES

Code	Tube			Thread	Dimensions		Pressure
	D.N.	Hose	Diam		D	L	
		Inch	mm		mm	mm	
B12T03N	-3	3/16"	4.8		21	23	
B12T04N	-4	1/4"	6.4		23	30	
B12T05N	-5	5/16"	7.9		24	30	
B12T06N	-6	3/8"	9.5		26	32	
B12T08N	-8	1/2"	12.8		29	34	
B12T10N	-10	5/8"	16		33	37	
B12T12N	-12	3/4"	19		37	42	
B12T16N	-16	1"	25.4		46	51	
B12T20N	-20	1.1/4"	31.8		59	59	
B12T24N	-24	1.1/2"	38.1		67	67	
B12T32N	-32	2"	50.8		80	72	

FERRULE FOR 1SC/1SN/2SC

BOCCOLA PER TUBO 1SC/1SN/2SC
 JUPE POUR 1SC/1SN/2SC
 PRESSHÜLSE 1SC/1SN/2SC
 CASQUILLO PARA 1SC/1SN/2SC

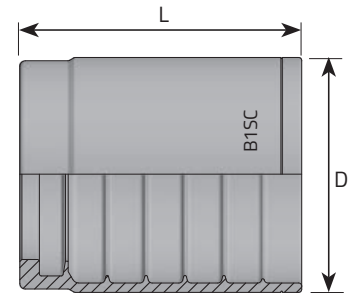

No skive - Senza pelatura - Non-dénudable -
 Nichtschaelfassung - Sin pelar

IDENTIFICATION: PRINTED CODE OR SCRATCHES

Code	Tube			Thread	Dimensions		Pressure
	D.N.	Hose	Diam		D	L	
		Inch	mm		mm	mm	
B1SC04	-4	1/4"	6.4		20	30	
B1SC05	-5	5/16"	7.9		22	30	
B1SC06	-6	3/8"	9.5		24	32	
B1SC08	-8	1/2"	12.8		28	34	
B1SC10	-10	5/8"	16		32	37	
B1SC12	-12	3/4"	19		35	42	
B1SC16	-16	1"	25.4		43	51	

FERRULE FOR 1SC-SLIM-R17-R7-R6 1TE/2TE

BOCCOLA PER TUBO 1SC-SLIM-R17-R7-R6 1TE-R6 2TE
 JUPE POUR 1SC-SLIM-R17-R7-R6 1TE-R6 2TE
 PRESSHÜLSE 1SC-SLIM-R17-R7-R6 1TE-R6 2TE
 CASQUILLO PARA 1SC-SLIM-R17-R7-R6 1TE-R6 2TE

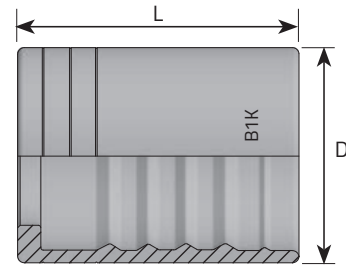

IDENTIFICATION: PRINTED CODE OR SCRATCHES

Code	Tube			Thread	Dimensions		Pressure
	D.N.	Hose	Diam		D	L	
		Inch	mm		mm	mm	
B1K04	-4	1/4"	6.4		18	30	
B1K05	-5	5/16"	7.9		20	30	
B1K06	-6	3/8"	9.5		22	32	
B1K08	-8	1/2"	12.8		26	34	
B1K10	-10	5/8"	16		30	37	
B1K12	-12	3/4"	19		33	42	
B1K16	-16	1"	25.4		41	51	
B1K20	-20	1.1/4"	31.8		48	57	
B1K24	-24	1.1/2"	38.1		56	66	
B1K32	-32	2"	50.8		68	70	

FERRULE FOR 1SN/R1AT

BOCCOLA PER TUBO 1SN/R1AT
 JUPE POUR 1SN/R1AT
 PRESSHÜLSE 1SN/R1AT
 CASQUILLO PARA 1SN/R1AT

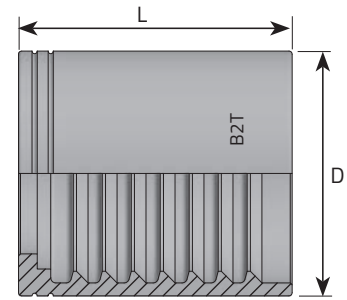

No skive - Senza pelatura - Non-dénudable -
 Nichtschaelfassung - Sin pelar

Code	Tube			Thread	Dimensions		Pressure
	D.N.	Hose	Diam		D	L	
		Inch	mm		mm	mm	
B1T03	-3	3/16"	4.8		19	26	
B1T04	-4	1/4"	6.4		20	30	
B1T05	-5	5/16"	7.9		22	30.5	
B1T06	-6	3/8"	9.5		24	32	
B1T08	-8	1/2"	12.8		29	34	
B1T10	-10	5/8"	16		32	37	
B1T12	-12	3/4"	19		36	42.5	
B1T16	-16	1"	25.4		43	50.5	
B1T20	-20	1.1/4"	31.8		53	59	
B1T24	-24	1.1/2"	38.1		60	63	

FERRULE FOR 2SN/R2AT

BOCCOLA PER TUBO 2SN/R2AT
 JUPE POUR 2SN/R2AT
 PRESSHÜLSE 2SN/R2AT
 CASQUILLO PARA 2SN/R2AT

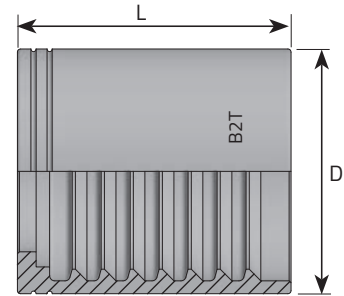

No skive - Senza pelatura - Non-dénudable -
 Nichtschaelfassung - Sin pelar

IDENTIFICATION: PRINTED CODE OR SCRATCHES

Code	Tube			Thread	Dimensions		Pressure
	D.N.	Hose	Diam		D	L	
		Inch	mm		mm	mm	
B2T03	-3	3/16"	4.8		20	26	
B2T04	-4	1/4"	6.4		22	30	
B2T05	-5	5/16"	7.9		24	30.5	
B2T06	-6	3/8"	9.5		25.5	31.5	
B2T08	-8	1/2"	12.8		30	34	
B2T10	-10	5/8"	16		34	37	
B2T12	-12	3/4"	19		38	42.5	
B2T16	-16	1"	25.4		46	50	
B2T20	-20	1.1/4"	31.8		56	59	
B2T24	-24	1.1/2"	38.1		64	63	

FERRULE FOR 1ST/R1A

BOCCOLA PER TUBO 1ST/R1A
 JUPE POUR 1ST/R1A
 PRESSHÜLSE 1ST/R1A
 CASQUILLO PARA 1ST/R1A

Skive - A pelare - Dénudable -
 Schaelfassung - A pelar

IDENTIFICATION: PRINTED CODE OR SCRATCHES

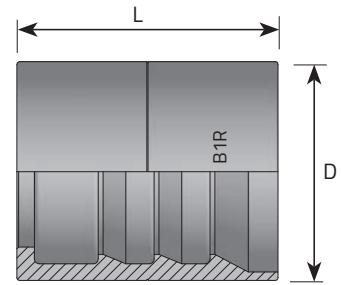

Code	Tube			Thread	Dimensions		Pressure
	D.N.	Hose	Diam		D	L	
		Inch	mm		mm	mm	
B1R03	-3	3/16"	4.8		17	26.5	
B1R04	-4	1/4"	6.4		20	29.5	
B1R05	-5	5/16"	7.9		22	29.5	
B1R06	-6	3/8"	9.5		24	32	
B1R08	-8	1/2"	12.8		29	34	
B1R10	-10	5/8"	16		32	37	
B1R12	-12	3/4"	19		36	43	
B1R16	-16	1"	25.4		43	50	
B1R20	-20	1.1/4"	31.8		52	57	
B1R24	-24	1.1/2"	38.1		57	63	
B1R32	-32	2"	50.8		70	78	

FERRULE FOR 2ST/R2A

BOCCOLA PER TUBO 2ST/R2A
 JUPE POUR 2ST/R2A
 PRESSHÜLSE 2ST/R2A
 CASQUILLO PARA 12ST/R2A

Skive - A pelare - Dénudable -
 Schaelfassung - A pelar

IDENTIFICATION: PRINTED CODE OR SCRATCHES

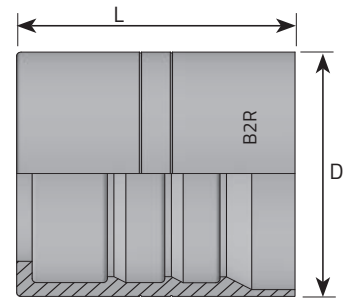

Code	Tube		Thread	Dimensions		Pressure
	D.N.	Hose		Diam	D	
		Inch	mm	mm	mm	
B2R03	-3	3/16"	4.8	20	27	
B2R04	-4	1/4"	6.4	22	30	
B2R05	-5	5/16"	7.9	24	30	
B2R06	-6	3/8"	9.5	26	32	
B2R08	-8	1/2"	12.8	30	34	
B2R10	-10	5/8"	16	34	37	
B2R12	-12	3/4"	19	38	43	
B2R16	-16	1"	25.4	46	50	
B2R20	-20	1.1/4"	31.8	56	59	
B2R24	-24	1.1/2"	38.1	62	63	
B2R32	-32	2"	50.8	75	79	

FERRULE FOR R3-R4

BOCCOLA PER TUBO R3/R4
 JUPE POUR R3/R4
 PRESSHÜLSE R3/R4
 CASQUILLO PARA R3/R4

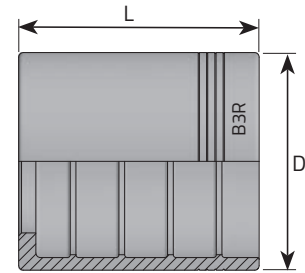

No skive - Senza pelatura - Non-dénudable -
 Nichtschaelfassung - Sin pelar

IDENTIFICATION: PRINTED CODE OR SCRATCHES

Code	Tube			Thread	Dimensions		Pressure
	D.N.	Hose	Diam		D	L	
		Inch	mm		mm	mm	
B3R04	-4	1/4"	6.4		19	29	
B3R05	-5	5/16"	7.9		22	30	
B3R06	-6	3/8"	9.5		24	31	
B3R08	-8	1/2"	12.8		28.5	34	
B3R10	-10	5/8"	16		32	36	
B3R12	-12	3/4"	19		38	42	
B3R16	-16	1"	25.4		46	50	
B3R20	-20	1.1/4"	31.8		52	57	

FERRULE FOR R9R-4SP

BOCCOLA PER TUBO R9R-4SP
 JUPE POUR R9R-4SP
 PRESSHÜLSE R9R-4SP
 CASQUILLO PARA R9R-4SP

Skive - A pelare - Dénudable -
 Schaelfassung - A pelar

IDENTIFICATION: PRINTED CODE OR SCRATCHES

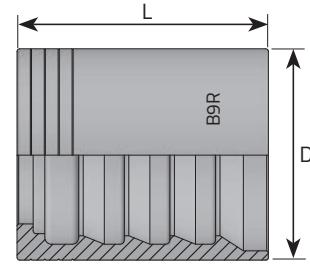

Code	Tube			Thread	Dimensions		Pressure
	D.N.	Hose	Diam		D	L	
		Inch	mm		mm	mm	
B9R04	-4	1/4"	6.4		22	30	
B9R06	-6	3/8"	9.5		26	32	
B9R08	-8	1/2"	12.8		30	34	
B9R10	-10	5/8"	16		34	40	
B9R12	-12	3/4"	19		38	45.2	
B9R16	-16	1"	25.4		46	56	
B9R20	-20	1.1/4"	31.8		59	66	
B9R24	-24	1.1/2"	38.1		65	76.5	
B9R32	-32	2"	50.8		80	80	

FERRULE FOR 4SH (skive)

BOCCOLA PER TUBO 4SH
 JUPE POUR 4SH
 PRESSHÜLSE 4SH
 CASQUILLO PARA 4SH

Skive - A pelare - Dénudable -
 Schaelfassung - A pelar

IDENTIFICATION: PRINTED CODE OR SCRATCHES

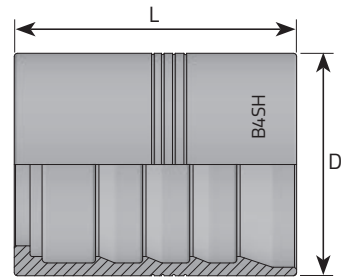

Code	Tube			Thread	Dimensions		Pressure
	D.N.	Hose	Diam		D	L	
		Inch	mm		mm	mm	
B4SH20	-20	1.1/4"	31.8		52	66	
B4SH24	-24	1.1/2"	38.1		62	76.5	
B4SH32	-32	2"	50.8		75	80	

FERRULE FOR R7/MTH 1/R6

BOCCOLA PER TUBO R7/MTH1/R6
 JUPE POUR R7/MTH1/R6
 PRESSHÜLSE R7/MTH1/R6
 CASQUILLO PARA R7/MTH1/R6

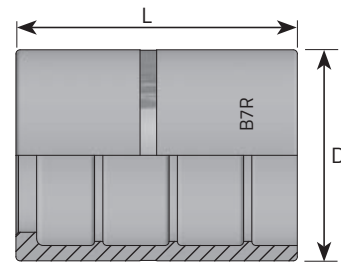

No skive - Senza pelatura - Non-dénudable -
 Nichtschaelfassung - Sin pelar

IDENTIFICATION: PRINTED CODE OR SCRATCHES

Code	Tube			Thread	Dimensions		Pressure
	D.N.	Hose	Diam		D	L	
		Inch	mm		mm	mm	
B7R03	-3	3/16"	4.8		14	30	
B7R04	-4	1/4"	6.4		17	30	
B7R05	-5	5/16"	7.9		19	30	
B7R06	-6	3/8"	9.5		21	30	
B7R08	-8	1/2"	12.8		25.5	34	
B7R10	-10	5/8"	16		28.5	36	
B7R12	-12	3/4"	19		32	42	
B7R16	-16	1"	25.4		40	50	

FERRULE FOR PTFE

BOCCOLA PER TUBO PTFE
 JUPE POUR PTFE
 PRESSHÜLSE PTFE
 CASQUILLO PARA PTFE

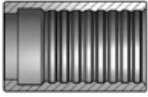

* version with grooves
 versione scanalata

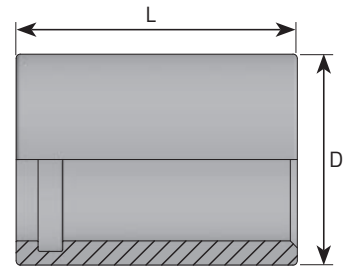

	Code	Tube			Thread	Dimensions		Pressure
		D.N.	Hose	Diam		D	L	
			Inch	mm		mm	mm	
*	BPTFE03	-3	3/16"	4.8		14	25	
	BPTFE04	-4	1/4"	6.4		16	26.5	
*	BPTFE05	-5	5/16"	7.9		17	25	
	BPTFE06	-6	3/8"	9.5		19	30	
	BPTFE08	-8	1/2"	12.8		24	32	
	BPTFE10	-10	5/8"	16		25.5	34	
	BPTFE12	-12	3/4"	19		30.5	40	
	BPTFE16	-16	1"	25.4		37	47	

FERRULE FOR PTFE CORRUGATED

BOCCOLA PER TUBO PTFE CORRUGATA
 JUPE POUR PTFE ONDULE'
 PRESSHÜLSE PTFE GEWELLT
 CASQUILLO PARA PTFE CORRUGADO

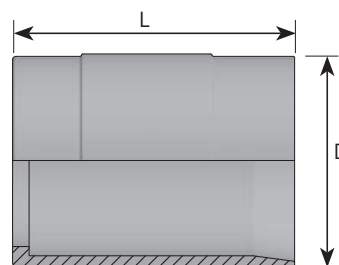

Code	Tube			Thread	Dimensions		Pressure
	D.N.	Hose	Diam		D	L	
		Inch	mm		mm	mm	
BPTFEC04	-4	1/4"	6.4		17.8	26.5	
BPTFEC06	-6	3/8"	9.5		20	30.5	
BPTFEC08	-8	1/2"	12.8		24	33	
BPTFEC10	-10	5/8"	16		29	31	
BPTFEC12	-12	3/4"	19		31.1	41	
BPTFEC16	-16	1"	25.4		38	47	
BPTFEC20	-20	1.1/4"	31.8		49.5	53	
BPTFEC24	-24	1.1/2"	38.1		55.3	58.5	
BPTFEC32	-32	2"	50.8		69	72	

FERRULE FOR 4SP/4SH/R12/ ELASTIK4000/ELASTIK5000

BOCCOLA PER TUBO 4SP/4SH/R12/ELASTIK 4000 / 5000
 JUPE POUR 4SP/4SH/R12 ELASTIK 4000 / 5000
 PRESSHÜLSE 4SP/4SH/R12 ELASTIK 4000 / 5000
 CASQUILLO PARA 4SP/4SH/R12 ELASTIK 4000 / 5000

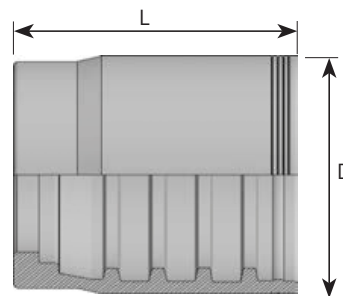

No skive - Senza pelatura - Non-dénudable -
 Nichtschaelfassung - Sin pelar

IDENTIFICATION: PRINTED CODE OR SCRATCHES

Code	Tube			Thread	Dimensions		Pressure
	D.N.	Hose	Diam		D	L	
		Inch	mm		mm	mm	
B5K06	-6	3/8"	9.5		33	33	
B5K08	-8	1/2"	12.8		35.5	36	
B5K10	-10	5/8"	16		40.5	40	
B5K12	-12	3/4"	19		43.5	44	
B5K16	-16	1"	25.4		51	54.4	
B5K204	-20	1.1/4"	31.8		62.5	63.5	
B5K206	-20	1.1/4"	31.8		66.5	63.8	

FERRULE FOR 1TE/R6

BOCCOLA PER TUBO 1TE/R6
 JUPE POUR 1TE/R6
 PRESSHÜLSE 1TE/R6
 CASQUILLO PARA 1TE/R6

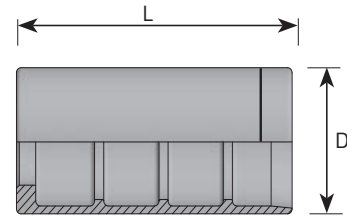

No skive - Senza pelatura - Non-dénudable -
 Nichtschaelfassung - Sin pelar

IDENTIFICATION: PRINTED CODE OR SCRATCHES

Code	Tube			Thread	Dimensions		Pressure
	D.N.	Hose	Diam		D	L	
		Inch	mm		mm	mm	
B6R03	-3	3/16"	4.8		14	30	